

CARSON

Carson Manufacturing Co., Inc.
5451 North Rural Street
Indianapolis, IN 46220
Phone: (888) 577-6877 Fax: (317) 254-2667
www.carsonsirens.com

SC-550-10 REMOTE SIREN AMPLIFIER / LIGHT CONTROL

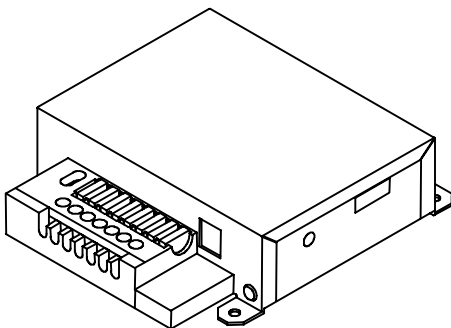
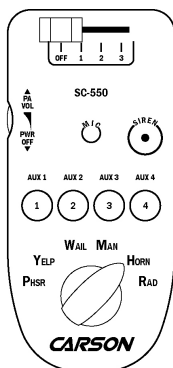

INSTALLATION AND OPERATING INSTRUCTIONS

Carson is a trademark of Carson Manufacturing Company, Inc.

WARNING  **Sound Hazard** - Sound level from siren speaker (>120dBA @ 10 feet) may cause hearing damage. Do not operate siren without adequate hearing protection for you and anyone in immediate vicinity. (Ref. OSHA 1910.95 for occupational noise exposure guidelines)

TABLE OF CONTENTS

GENERAL DESCRIPTION 3

SPECIFICATIONS 3

INSTALLATION 4

 SAFETY PRECAUTIONS 4

 UNPACKING 4

 OPTION SWITCHES 4

 ELECTRICAL CONNECTIONS 5

 MOUNTING 7

 RADIO VOLUME ADJUST 7

OPERATION 8

 GENERAL 8

 SIREN CONTROLS 8

 Power Switch / PA Volume 8

 Rotary Function Switch 8

 PA 8

 Siren Button and Auxiliary Siren Input 8

 Horn Ring Cyclor 2 (HRC2) 8

 Cutout 8

 LIGHT CONTROLS 9

 Slide Switch 9

 Slide Switch Reverse 9

 Automatic Siren 9

 Auxiliary Output Switches 9

 Legends 9

SERVICE 10

PROBLEMS 10

PARTS 11

RETURN 11

LIMITED WARRANTY 11

INSTALLATION INFORMATION 12

NOTICE

Due to continuous product improvements, we must reserve the right to change any specifications and information, contained in this manual at any time without notice.
 Carson Manufacturing Co., Inc. makes no warranty of any kind with regard to this manual, including, but not limited to, the implied warranties of merchantability and fitness for a particular purpose.
 Carson Manufacturing Co., Inc. shall not be liable for errors contained herein or for incidental or consequential damages in connection with the furnishing, performance, or use of this manual.

GENERAL DESCRIPTION

The SC-550 Remote Siren Amplifier with integrated Lighting Control is a premium unit designed for single or dual 100W speaker use. A remote hand control is connected to the amplifier with a thin cable. A 6-position rotary switch controls the primary operating modes of Phaser, Yelp, Wail, Manual, Horn and Radio. A siren button and auxiliary siren input is provided for control of the output tone, depending on the rotary switch setting. An integral microphone provides PA function. The power switch is combined with the PA volume control. A hole is provided in the amplifier to adjust Radio volume. A 4-position progressive slide switch controls primary lighting and may automatically activate the siren. Non-progressive slide switch outputs provided for tailored lighting. Four auxiliary output pushbuttons provide for controlling additional lighting or other devices. A latching siren cutout input is provided for connection to a door switch, etc. to disable the siren when exiting the vehicle. An 8-position DIP switch on the amplifier allows selection of various options: Two-Tone to replace Phaser, Phaser disable, Horn disable, short Manual, and Horn Ring Cyclor 2 (HRC2). Auxiliary siren and cutout input activation polarity along with disabling automatic siren and slide switch reverse are additional options. The hand control is backlitged with LED's for night visibility. The siren amplifier utilizes short circuit, high voltage, and reverse polarity protection systems for maximum service life over a wide temperature range. The slide switch and auxiliary outputs are fused individually.

SPECIFICATIONS

| Siren Amplifier | | | | | |
|----------------------------|---|--------|---------|--------|----------|
| Input Voltage | 11 - 16 VDC (negative ground) | | | | |
| Input Current | 8 AMPS (@14 VDC - single 100W speaker) 16 AMPS (@14 VDC - dual 100W speakers) | | | | |
| Standby Current | Less than 200 ma | | | | |
| Audio Frequency | 200Hz - 10 kHz ± 3db | | | | |
| Audio Distortion | Less than 3% (@1 kHz - single 100W speaker) | | | | |
| Audio Output | 40 watts (@14 VDC - single 100W speaker) | | | | |
| Audio Input | 400 ohms ± 10% | | | | |
| Output Power | 105 WATTS RMS MAX. (15 VDC - single 100W speaker) 180 WATTS RMS MAX. (15 VDC - dual 100W speakers) | | | | |
| Siren Frequency | 700Hz - 1500Hz (Two-Tone and Horn = 435 & 585Hz) | | | | |
| Tones / Cycle Rates | Horn | Wail | Yelp | Phaser | Two-Tone |
| Cycle Rates | 109 CPS | 13 CPM | 190 CPM | 15 CPS | 60 CPM |
| High Voltage Prot. | 16 - 18 VDC will cause siren output to cease, resume at normal | | | | |
| Short Circuit Current | 50 AMPS (supply circuit must be capable of supplying this) | | | | |
| Operating Temp. | -15° F to +140°F | | | | |
| Controls | 6-position rotary mode switch (Phaser, Yelp, Wail, Manual, Horn and Radio). Momentary push-button Siren switch. PA volume with Power switch on Hand Control, Radio volume on Amplifier. Auxiliary input connection programmable for positive or negative activation. Cutout input connection programmable for positive or negative latching cutout operation. | | | | |
| Connections (10-Pin Conn.) | (2) Negative, (2) Speaker, (2) Radio, Cutout, Auxiliary Siren, (2) non-progressive slide switch outputs (500mA Max. per output) Note: positive siren connection is through high current input | | | | |
| Light Controls | | | | | |
| Voltage | 11 - 16 VDC (negative ground) | | | | |
| Controls | 4-position progressive slide switch with automatic siren activation (4) auxiliary pushbuttons | | | | |
| High Current Input | (2) pressure terminals, 140 AMPS Max. not including siren input current | | | | |
| Slide Switch Outputs | (3) pressure terminals, 20 AMPS Max. per terminal | | | | |
| 4 Auxiliary Outputs | (4) pressure terminals, 20 AMPS Max. per terminal | | | | |
| General | | | | | |
| Size | Hand Control: 2-3/4" Wide, 1" Deep, 6" High Amplifier: 7-1/2" Wide, 6-3/4" Deep, 2-1/8" High | | | | |
| Weight | 5-1/2 LBS. | | | | |

INSTALLATION

Proper installation of the unit is essential for years of safe, reliable operation. Please read all instruction **before** installing the unit. Failure to follow these instructions can cause serious damage to the unit or vehicle and may void warranties.

SAFETY PRECAUTIONS

For the safety of the installer, vehicle operator, passengers and the community please observe the following safety precautions. **Failure to follow all safety precautions and instructions may result in property damage, injury or death.**

Qualifications - The installer must have a firm knowledge of basic electricity, vehicle electrical systems and emergency equipment.

WARNING **Sound Hazard** - Sound level from siren speaker (>120dBA @ 10 feet) may cause hearing damage. Do not operate siren without adequate hearing protection for you and anyone in immediate vicinity. (Ref. OSHA 1910.95 for occupational noise exposure guidelines)

Hand Control Location - Locate the hand control for easy access by the vehicle operator. DO NOT locate in air bag deployment area.

Amplifier Mounting - DO NOT mount in air bag deployment area. Assure clearances before drilling in vehicle.

Wiring - Use wiring capable of handling the current required. Make sure all connections are tight. Route wiring to prevent wear, overheating and interference with air bag deployment. Install and check all wiring before connection to vehicle battery.

Testing - Test all functions after installation to assure proper operation. Test vehicle operation to assure no damage to vehicle.

Keep These Instructions - Keep these instructions in the vehicle or other safe place for future reference. Advise the vehicle operator of the location.

UNPACKING

Inspect contents for shipping damage. If found **alert carrier immediately**. Contents should include hand control, amplifier, removable terminal block plug, and these instructions. Contact supplier immediately if any components are missing.

OPTION SWITCHES

Various options can be controlled by turning on or off any of 8 DIP switches on the amplifier.

Switch 1 On: **Positive Cutout Input Polarity** - Cutout is normally activated with negative input. This switch changes to positive activation.

Switch 2 On: **Positive Auxiliary Siren Input Polarity** - Auxiliary siren is normally activated with negative input. This switch changes to positive activation.

Switch 3 On: **Two-Tone** - Two-Tone replaces Phaser function.

Switch 4 On: **Phaser Disable** - The Phaser and Two-Tone function are disabled.

Switches 3 & 4 On: **Horn Ring Cycler 2 option (HRC2)** - This option allows selection of Wail, Yelp, and Phaser by repeatedly tapping the Siren button, horn ring or other switch connected to the auxiliary siren input. Tapping the horn ring twice quickly will stop siren tones. Holding the horn ring produces Horn.

NOTE: Earlier units with S/N lower than 04190000 have a different version of HRC. In this case the siren tones cycle through Standby, Wail, Yelp, and Phaser. The tone is stopped by cycling to Standby.

Switch 5 On: **Horn Disable** - The Horn function is disabled.

Switch 6 On: **Short Manual** - The Manual function can be set to immediately cut off when the Siren button is released.

Switch 7 On: **Automatic Siren Disable** - The Automatic Siren feature associated with the slide switch may be disabled.

Switch 8 On: **Slide Switch Reverse** - The progressive slide switch normally activates L1 output in position 1 and L1, L2, L3 outputs in position 3. Setting this option on activates L1, L2, L3 outputs in position 1 and L1 output in position 3.

ELECTRICAL CONNECTIONS

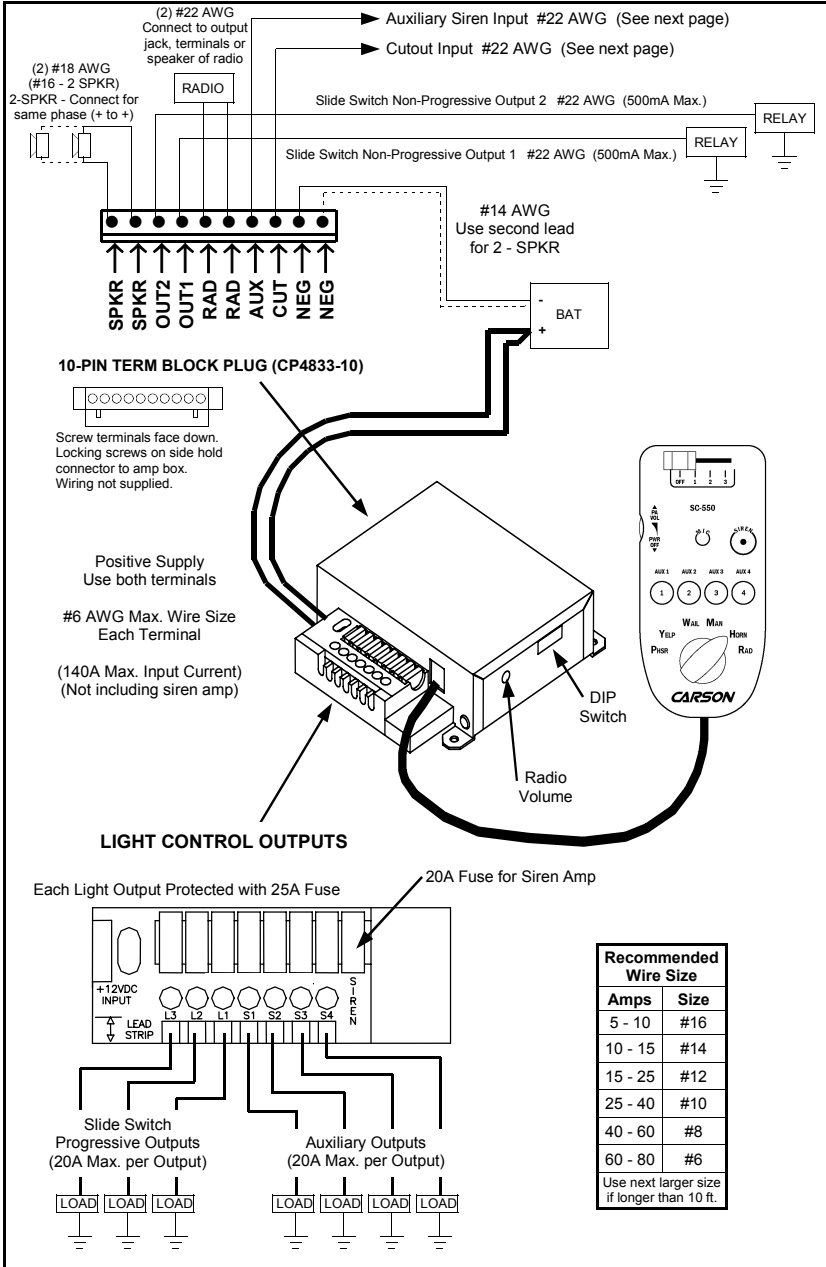

ELECTRICAL CONNECTIONS

Connections are made using pressure terminal connectors. Legends on the unit identify each terminal function. Attach leads by stripping 3/8", inserting into connector and clamp by tightening screw. Make sure the screw is tight and the wire can't be pulled out. **Failure to adequately tighten the screw can result in improper operation or burning the connector and wire.**

Positive Supply: Due to the high current nature of this unit, an appropriate supply line is required. In addition to the high current delivered to devices on the outputs, the siren amplifier will require peak currents up to 50 amps for adequate short circuit protection and reliable operation. The preferred source is directly at the vehicle battery.

Negative Supply: The negative supply line is for the siren amplifier. The siren amplifier will require peak currents up to 50 amps for adequate short circuit protection and reliable operation. The preferred source is directly at the vehicle battery.

Speaker: Both connections must be used. Two speakers may be connected in parallel. Observe polarity (phasing) for maximum sound output.

Radio (Optional): Both connections must be used. The input is isolated and polarity is not important. May need to adjust RADIO VOLUME on side of amplifier.

Auxiliary Siren (Optional): The auxiliary siren input allows activation of the Siren button with an external source. The OPTION SWITCH determines polarity of activation.

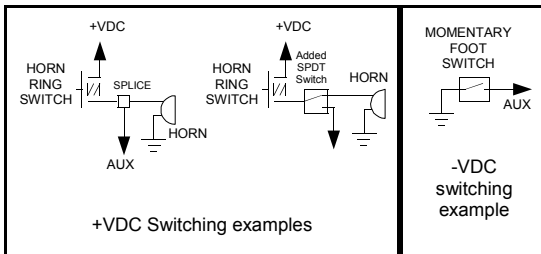

Cutout (Optional): The cutout input turns off any siren tone when activated, and remains off until a siren control is changed. The OPTION SWITCH determines polarity of activation.

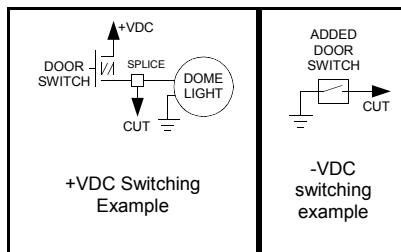

L1, L2, L3 Outputs: These outputs are controlled by the slide switch in a progressive fashion. Outputs are fused.

S1 to S4 Outputs: These outputs are controlled individually by pushbutton switch 1 to 4. Outputs are fused.

**OUT1,2 Outputs
(Optional):**

Controlled by the slide switch in a non-progressive fashion. See Slide Switch under Light Controls. These outputs **are not fused** and are intended to control external relays. When turned on the output supplies +VDC @ 500mA max. When turned off the output is open (high impedance).

MOUNTING - Hand Control

Choose a mounting location convenient to the operator and away from any air bag deployment areas. Consider cable routing to amplifier as well as PA use. Mount the hand control with supplied Hook and Loop tape (VELCRO). If the tape method is not preferred, the hand control may be mounted several ways including a cell phone holder. Plug cable into amplifier, no other electrical connections are necessary.

MOUNTING - Amplifier

Select a location for the amplifier in an area such as the driver compartment firewall, under a seat, etc. Mounting the amplifier in the engine compartment or in an area directly exposed to weather is not recommended. Assure adequate ventilation to prevent overheating. Allow clearance for wiring and radio adjustment. Inspect behind mounting area for clearance. Mark the location of the mounting holes to be drilled.

Drill 4 holes (up to 1/4" diameter) to mount the amplifier to the vehicle. Install the removable terminal block plug and make all electrical connections before final mounting (See ELECTRICAL CONNECTIONS). The plug may be secured with the two locking screws. Then mount the amplifier to the vehicle using appropriate hardware (not supplied).

RADIO VOLUME ADJUST

If the Radio repeat mode of the siren is going to be used then the RADIO VOLUME control may need to be adjusted. This is a one time setting which depends on the radio connected and its normal volume. On the hand control, set the slide switch to OFF, set the rotary switch to RADio, and power switch to ON. With the volume on the radio itself set to normal level, set the RADIO VOLUME control to the desired output level.

OPERATION

WARNING Sound Hazard - Sound level from siren speaker (>120dBA @ 10 feet) may cause hearing damage. Do not operate siren without adequate hearing protection for you and anyone in immediate vicinity. (Ref. OSHA 1910.95 for occupational noise exposure guidelines)

GENERAL

This unit is designed for easy operation under the stress associated with high-speed pursuit. Most functions are accessible with one simple motion without repetitive activation of switches or automatic timed switching that can interfere with desired operation.

SIREN CONTROLS

The combined power switch and volume control give power to the hand control and adjust the PA volume. Power is turned **OFF** by rotating the control counterclockwise until it "clicks". Power is turned **ON** and increased PA volume by rotating clockwise. The power switch should be turned off when vehicle is not being used to conserve battery power.

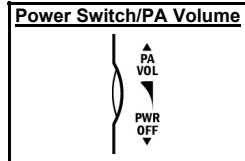

The Rotary Function Switch selects various siren operating modes. These modes are as follows:

PhaSeR: The siren produces a very fast warble tone. This mode may be used at intersections or in highly congested areas. Horn and PA override available in this mode.

YELP: The siren produces a moderate warble tone. This mode may be used in lightly congested areas. Horn and PA override available in this mode.

WAIL: The siren produces a normal rise-fall tone pattern. This mode may be used on highways or areas with constant traffic flow. Yelp and PA override available in this mode.

MANual: The siren rise-fall tone is controlled manually with the Siren button. PA override available in this mode.

HORN: Also considered a standby mode. Horn and PA override available in this mode.

RADio: This mode reproduces, or repeats, the output of a radio. The radio must be connected and the RADIO VOLUME adjusted. PA override available in this mode.

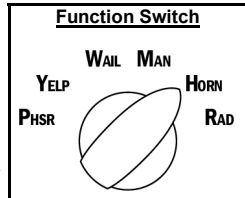

The following **OVERRIDE FUNCTIONS** are for certain modes.

PA: By pressing the microphone PTT (Push to Talk) switch on the side of the hand control, the siren will change to a PA (Public Address) amplifier. The siren mode resumes when the PTT is released. Adjust the PA Volume and hold the MIC close to your lips for proper operation. PA override is available in all modes.

HORN: By momentarily pressing the Siren button or activating the auxiliary siren input, the HORN tone is produced. The siren mode resumes when released. Horn override is available in all modes except Radio and Wail.

YELP: Only available in Wail mode. By momentarily pressing the Siren button or activating the auxiliary siren input, the siren output is toggled between Wail and Yelp tone.

HRC2: Horn Ring Cyclor 2 is only available in Horn (Standby) mode and must be enabled with the option switches. Tap the horn ring to bring the unit out of standby into Wail tone. Repeatedly tapping the horn ring will cycle through Wail, Yelp, and Phaser tones. Tapping the horn ring twice quickly will stop the siren tones and return the unit to standby. Pressing and holding the horn ring will produce Horn tone until released. Then the siren returns to its previous siren tone or standby.. If automatic siren is active, then tones are not stopped. See OPTION SWITCHES section for further details.

CUTOUT: The cutout input turns off any siren tone when activated, and remains off until a siren control is changed.

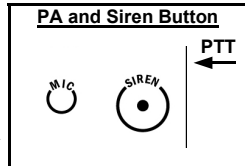

LIGHT CONTROLS

A 4-position slide switch provides control of primary lighting functions. It also provides automatic activation of the siren. Four pushbuttons for additional lighting or controlling other devices. The power switch on the hand control must be **ON** for light controls to function.

Slide Switch

The slide switch provides progressive (additive) control of lighting functions. Position 1 turns on L1 output. Position 2 turns on L1 and L2 outputs. Position 3 turns on L1, L2, and L3 outputs. Position 3 also turns on the siren (Automatic Siren).

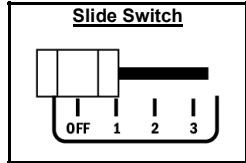

The slide switch position outputs OUT1 and OUT2 are for setups that require a non-progressive slide switch. Only Position 1 will turn on OUT1. Only Position 2 will turn on OUT2. In Position 3 the L3 output can be used since only Position 3 will turn this on.

Note that OUT1 and OUT2 **are not fused** and intended to drive external relays. These outputs can only drive loads up to 500mA each.

Slide Switch Reverse

The Option Switch can be set to reverse the slide switch positions. Position 1 and Position 3 operations are reversed or swapped.

| Slide Switch Position | Slide Switch Reverse OFF | Slide Switch Reverse ON |
|-----------------------|--------------------------------|--------------------------------|
| OFF | L1, L2, L3, OUT1, OUT2 ALL OFF | L1, L2, L3, OUT1, OUT2 ALL OFF |
| 1 | L1, OUT1 ON | L1, L2, L3 ON (Auto Siren) |
| 2 | L1, L2, OUT2 ON | L1, L2, OUT2 ON |
| 3 | L1, L2, L3 ON (Auto Siren) | L1, OUT1 ON |

Automatic Siren

Position 3 of the Slide Switch (or 1 with Slide Switch Reversed) provides Automatic Siren. If the siren controls are set where there is no siren tone output, the Automatic Siren will override with Wail. The only exception is PA Override or Cutout activation. Automatic Siren may be disabled with the Option Switch.

Auxiliary Output Switches

Four pushbutton switches are provided for various other lighting functions or device control. Legends above the switch light up when the switch is on.

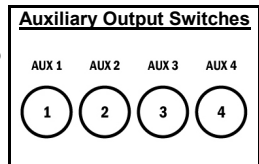

Legends

Different legends may be selected to match the device controlled by aux output switch. A sheet of stick-on legends is supplied.

Select the legend and place centered over the legend area. Press down on the legend to stick over clear window and tuck under rubber framing. Gently lift up on the sides of rubber framing to help cover the edges of the legend.

To remove a legend, use a thin edge to gently push rubber frame aside and pry between legend and clear window. Try not to puncture clear window. The stick-on adhesive is strong.

Blank (black) legends are provided for aux output switches with no function. The white background legends may be written on with permanent marker to create custom legends.

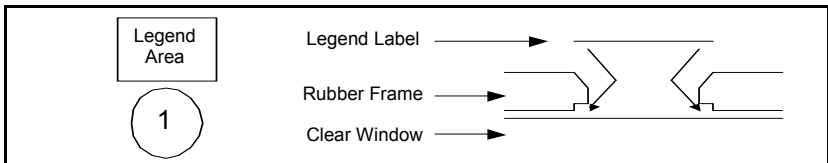

SERVICE

This unit is designed to provide years of reliable service under even the worst conditions. Many times there may appear to be a problem with the unit when the true problem is in the speaker(s), controlled devices, or improper installation. The following chart shows typical symptoms and possible causes.

A blown **siren** fuse doesn't necessarily mean that the unit is bad. If a speaker or speaker lead is shorted the fuse will blow before the unit is damaged. Disconnect the SPKR leads and replace the fuse. If the unit itself emits a low level sound when in the Yelp position it is OK. Check the speaker(s) or leads for possible shorting.

25A Fuses are required for each light control output. Adequate fuse rating is required to prevent overheating of the output connection block.

PROBLEMS

| Symptom | Possible Cause | Check |
|---|---|--|
| No power or siren output | Power switch not turned on Bad Speaker Connector or connections loose Siren fuse blown Loose connection at power source | Does backlighting come on? Do you hear a "pop" when turned on? With siren on, yelp selected, listen for tone in amplifier. Is an external fuse or circuit breaker used? Are the power leads connected to a good buss? |
| No siren tone - PA works | High Voltage Protection PA PTT button stuck Cutout activated Cutout Polarity Option set wrong | The input voltage must be less than highest rating. Does PTT button release properly? Does the siren work when Cutout input is disconnected? Is the Cutout Input Polarity option properly configured? |
| No PA | PA volume not set properly | Have you tried turning the PA volume control? |
| Distorted siren sound | Speaker assembly loose Intermittent Aux Input connection Low vehicle voltage | Is the speaker bell or tip loose? Is the Aux Siren Input used and wired properly? The input voltage must be greater than lowest rating. |
| Intermittent siren tone | High Voltage Protection Connector or connections loose Loose connection at power source PA PTT button activation Circuit breaker in supply connection | Is the vehicle voltage regulator working properly? Is the connector tight on the back of the unit? Check for loose leads back to power source. Is something lying on the PTT button? Is a circuit breaker used with at least a 50A rating? |
| Horn function stuck on or Manual or Phaser stuck on | Siren button switch stuck Aux Siren switch stuck Aux Input improperly connected Aux Input Polarity Option set wrong | Does the Siren button switch return fully when released? Does the Aux Siren switch return fully when released? Is the Aux Siren Input used and wired properly? Is the AUX Siren Polarity option properly configured? |
| No Radio | Unit not connected to radio Radio volume too low | Is the radio connected properly to the unit? Can you here the radio in the vehicle? Have you tried setting the Radio Volume Adjust? |
| Wrong siren tone | Two-Tone option selected | Is the Two-Tone option set? |
| Phaser not working | Phaser disabled | Is the Phaser Disable option set? |
| Horn not working | Horn disabled | Is the Horn Disable option set? |
| Manual stops immediately | Short Manual enabled | Is the Short Manual option set? |
| Automatic Siren not working | Automatic Siren disabled | Is the Automatic Siren Disable option set? |
| | | |
| Light Output not working | Light Control Output fuse blown Internal relay contacts bad | Is the light or device shorting? Is the output current limited to 20A? |
| Light Output stays on | Internal relay contacts fused from overheating | Is the output current limited to 20A? |
| Non-progressive output not working | Internal switching transistor bad | Is the external relay coil shorting? Is the output current limited to 500mA? |
| Slide switch outputs turn on in wrong order | Slide Switch is reversed | Is the Slide Switch Reverse option set? |

PARTS

| Part | Description |
|--------------|---|
| CP4177 | Cable, Coil Cord W/Modular Connector (Hand Control) |
| CP4732 | Control, 1K Vertical Trimmer (Amplifier) |
| F-16SP/12276 | Control, 1K PA Volume w/Power Switch (Hand Control) |
| CP4833-10 | Connector, 10-pin Terminal Block Plug w/Locking Screws (Wiring not included) |
| ATO/ATC 20A | Fuse, 20 Amp Automotive (Siren) |
| ATO/ATC 25A | Fuse, 25 Amp Automotive (Light Output) |
| 1555 KNOB | Knob, Black Selector Switch |
| CP4895 | Label, Aux Output Legends |
| CP4701 | Relay, 40A Light Control Output |
| CP3902 | Switch, Rotary 6-Position Selector |
| CP4119 | Transistor, output (2 required) (Industry standard TIP36C, Not Texas Instruments) |
| CP4818 | Manual, SC-550-10 14 Instruction |
| | |
| Accessories | |
| ED1753 | Cable, kit, hand control extension 15FT (includes CP4652 shielded cable and CP4141 modular coupler) |

RETURN

If you have any questions concerning this or any other Carson product, please contact our **Technical Service Department** at (888) 577-6877. Many issues can be handled over the phone. We can also be reached via e-mail at service@carsonsirens.com

If a product must be returned for any reason, please contact our Technical Service Department to obtain a Returned Merchandise Authorization number (RMA#) before you ship the product to Carson. Please write the RMA# clearly on the package near the mailing label. Be sure to provide a return address, contact and phone number, along with a brief description of the problem.

LIMITED WARRANTY

Carson Manufacturing Company, Inc. warrants this new product to be free from defects in material and workmanship, under normal use and service, for a period of five (5) years from the date of delivery to the first user-purchaser.

During this warranty period the obligation of Carson Manufacturing is limited to repairing or replacing, as Carson Manufacturing may elect, any part or parts of such product which after examination by Carson Manufacturing is determined to be defective in material and/or workmanship.

This warranty does not cover labor charges for removal or re-installation of the product. Fuses and lamps are not covered under this warranty.

This warranty does not extend to any unit that has been subjected to abuse, misuse, improper installation or which has not been adequately maintained, nor to units which have problems related to service or modification at any facility other than Carson Mfg.

THERE ARE NO OTHER WARRANTIES, EXPRESSED OR IMPLIED, INCLUDING BUT NOT LIMITED TO, ANY IMPLIED WARRANTIES OF MERCHANTABILITY OR FITNESS FOR A PARTICULAR PURPOSE. IN NO EVENT SHALL CARSON MANUFACTURING COMPANY, INC. BE LIABLE FOR ANY LOSS OF PROFITS OR ANY INDIRECT OR CONSEQUENTIAL DAMAGES ARISING OUT OF ANY SUCH DEFECT IN MATERIALS OR WORKMANSHIP.

INSTALLATION INFORMATION

MODEL: SC-550 _____

SERIAL NO: _____

PURCHASE DATE: _____

DEALER: _____

INSTALLER: _____

INSTALL DATE: _____

Auxiliary Siren Connection _____

Cutout Connection _____

OPTIONS

_____ Two-Tone instead of Phaser

_____ Phaser and Two-Tone Disable

_____ HRC2 enabled

_____ Horn disabled

_____ Short Manual

_____ Automatic Siren disabled

_____ Slide Switch Reversed

_____ Auxiliary Siren Input Polarity

_____ Cutout Input Polarity

SLIDE SWITCH

L1: _____ **OUT1:** _____

L2: _____ **OUT2:** _____

L3: _____

AUXILIARY OUTPUTS

S1: _____ **S3:** _____

S2: _____ **S4:** _____